

8.

Operation and Maintenance

This chapter provides guidance on the effective operation and maintenance of excreta disposal facilities.

8.1 Public health promotion

Any excreta disposal programme must include the promotion of public health. This means that communities must be mobilized to promote appropriate hygiene practices related to the design, use and maintenance of facilities.

A number of studies have suggested that the impact of hygiene practices on sanitation-related disease could be as great as that of the actual provision of sanitation facilities. Public health and hygiene promotion is widely believed to be one of the most effective means we have to reduce the toll of diarrhoeal diseases. It can also be an effective way to encourage participation and empower communities. Public health promotion in relation to excreta disposal should focus on:

- the appropriate use and maintenance of excreta disposal facilities;
- the safe disposal of faeces (especially those of children);
- handwashing after defecation and prior to food preparation;
- the use and safe disposal of appropriate anal-cleansing material;
- the control of flies and other insect vectors.

Practitioners should keep to the following seven principles of hygiene promotion (from Curtis, 1999):

EXCRETA DISPOSAL IN EMERGENCIES

1. Target a small number of risk practices – from the viewpoint of controlling diarrhoeal disease, the priorities for hygiene-behaviour change are likely to include handwashing with soap (or a local substitute) after contact with faeces, and the safe disposal of adults' and children's faeces.
2. Target specific audiences – these may include mothers, children, older siblings, fathers, opinion leaders, or other groups. One needs to identify who is involved in childcare, and who influences them or takes decisions for them.
3. Identify the motives for changed behaviour – these motives often have nothing to do with health. People may be persuaded to wash their hands so that their neighbours will respect them, so that their hands smell nice, or for other motives. By working with the target groups, one can discover their views of the benefits of the safer hygiene practices. This provides the basis for a motivational strategy.
4. Hygiene messages need to be positive – people learn best when they laugh, and will listen for a long time if they are entertained. Programmes which attempt to frighten their audience will alienate them. There should be no mention, therefore, of doctors, death or diarrhoea in hygiene promotion programmes.

The only exception to this is an acute epidemic-related emergency, such as a cholera outbreak, when a more directive approach may be necessary, whereby people are informed of the disease risks and transmission routes, and are made aware of the key practices required to tackle these.

5. Identify appropriate channels of communication – we need to understand how the target audiences communicate. For example, what proportion of each listens to the radio, attends social or religious functions, or goes to the cinema? Traditional and existing channels are easier to use than setting up new ones, but they can only be used effectively if their nature and capacity to reach people are understood.
6. Decide on a cost-effective mix of channels – several channels giving the same messages can reinforce one another. There is always a trade-off between reach, effectiveness and cost. Mass media reach many people cheaply, but their messages are soon forgotten. Face-to-face communication can be highly effective in encouraging behaviour change, but tends to be very expensive per capita.

7. Hygiene promotion needs to be carefully planned, executed, monitored and evaluated – at a minimum, information is required at regular intervals on the outputs (e.g. how many broadcasts, house visits, etc.), and the population coverage achieved (e.g. what proportion of target audiences heard a broadcast?). Finally, indicators of the impact on the target behaviours must be collected and fed into the planning process.

For more detailed information on hygiene promotion, refer to Ferron, Morgan & O'Reilly (2006) *Hygiene Promotion: From relief to development*. Intermediate Technology Development Group Publications: UK.

8.2 Cleaning and maintenance

The cleaning and maintenance of excreta disposal facilities, especially communal latrines, is often the single biggest problem faced in promoting their use. Put simply, **if latrines are not clean, people will not use them**. Latrines should be cleaned daily to prevent disease transmission through contact with faeces and flies and, perhaps more crucially, to prevent insanitary conditions and odour which may deter people from using them.

Individual families should be responsible for their own units but, where there are communal facilities, special arrangements must be made to keep them clean. Members of the affected community can usually be effectively employed through paid work or other incentives to undertake these tasks with proper supervision, equipment and training. Education should also be provided to the wider community to ensure that people are aware of the importance of using provided sanitation facilities and the uptake of corresponding hygiene practices, such as handwashing. Where there are latrines at health centres, particular attention should be paid to their maintenance and cleanliness as patients are likely to be more susceptible to disease.

Even where latrines are not particularly well-designed and there are no lids on drop-holes, thorough cleaning and maintenance are the key measures in reducing odour and flies. When cleaning latrines, disinfectants such as chlorine can be used to clean squatting-plates but should **not** be poured into pit latrines or tanks as this inhibits the natural biological degradation of the excreta. Public health promotion activities are crucially important to mobilize communities to promote and ensure the cleanliness of latrines.

Although thorough cleaning can go a long way towards controlling and reducing flies or smells, it is generally accepted that most latrines will attract some level of these. Pit latrines should be at least 6 metres away from shelters and other buildings to minimize the effects of odour, flies and pests from bothering or harming the population (UNHCR, 2000).

Some key issues to consider when implementing latrine-cleaning programmes are presented below:

- Where latrines belong to individual families or are shared by two to four families it is generally easy to encourage them to clean and maintain their own latrines (responsibility rotating between families weekly).
- Where communal facilities are in place (i.e. shared by more than four families) it is almost always necessary to employ some members of the affected community to clean and maintain latrines; this provides employment and helps to avoid conflict between community members.
- Co-ordination with other agencies working in the same area is important to ensure that a consistent approach is adopted, if people in one location are paid for O&M and people in another location are expected to perform the same tasks on a purely voluntary basis this is likely to create unrest.
- For large sites, such as large camps, the sheer volume of work required for appropriate O&M is huge. This makes the scale of supervision difficult and it is important that community members are empowered to manage this wherever possible.
- The quantity of equipment required for cleaning (disinfectants, mops, rags etc.) may also be considerable and an appropriate distribution system must be developed. This is commonly implemented in conjunction with a hygiene promotion programme.

8.3 Handwashing

Many studies have been conducted demonstrating the importance of handwashing with soap as an important means of reducing the risk of diarrhoeal disease in regular development and during emergencies as a means of improving public health conditions. Studies generally indicate

8. OPERATION AND MAINTENANCE

that washing hands with soap can reduce the risk of diarrhoeal disease by 42-47% (Curtis and Cairncross, 2003); while a study in a refugee camp in Malawi indicated that the presence of soap in a household led to a reduction of 27% of diarrhoeal episodes (Peterson et al., 1998).

Because diarrhoeal diseases are of faecal origin, interventions are needed which prevent faecal material from entering the domestic environment. The key primary barriers to the transmission of enteric pathogens are safe stool-disposal and adequate handwashing, especially after contact with faecal materials during anal-cleansing of adults and children.

If diarrhoea is a major problem – with evidence or risk of high morbidity or mortality (and it often is) – the focus of response should be excreta disposal, handwashing, protection of water from contamination and the provision of clean water in adequate quantities. The necessary software or promotional interventions should similarly focus intensively on these aspects until the risks have been mitigated.

Handwashing with soap (or ash if soap is not available) should be promoted at three key times: after defecation; after cleaning child excreta and before eating or preparing a meal.

Excreta disposal facilities should, wherever possible, be accompanied by appropriate handwashing facilities. The task of handwashing is an ambiguous and awkward activity simply because one's hands must be used for the task of washing one's hands. A number of appropriate technical solutions have been used in the past to make handwashing easier, more convenient and more accessible.

These solutions include the following:

- The preferred option is to have a tap near each latrine connected to a piped water system.
- Miscellaneous containers with taps fitted to them (see Figures 8.1 and 8.2).
- Small leaking containers fitted with a handle. The leaky container is used to provide water sparingly by dipping it into a body of water and hanging it up. The water then drizzles out through a small hole in the bottom over a person's hands.
- The 'Tippy Tap' (Cairncross and Curtis, 2003) has been one of the more well-known and popular designs from the viewpoint of the development worker. The Tippy Tap is made from an old cooking

EXCRETA DISPOSAL IN EMERGENCIES

container or similar that is suspended. It allows water to flow into a spout when it is tipped upright and drizzle out through a small hole in the end of the spout onto the hands (see Figure 8.3).

- The 'Handy Andy' is a small plastic device which is fitted into a reservoir or container and works by releasing water in small amounts when the user pushes up the plastic pin in the bottom (see Figure 8.3).
- The handwashing dispenser unit is a plastic moulded device designed and developed in South Africa. It screws onto a plastic drinking-bottle filled with water. The bottle is then turned upright and fits into a wall bracket ready to dispense small amounts of water when an inverted plunger is lifted.
- The 'Captap' (Harries, 2004) is a spring-loaded device that fits into the cap of a jerrycan. You dispense water through the centre of the cap by moving the handle, up or down. The Captap stems the flow of water by using a rubber seal that is pulled against the inside of the cap under the tension of the spring. The seal is made out of a bicycle or car-tyre tube (see Figure 8.3).



Photograph 8.1. The 'Captap' in use in Liberia

8. OPERATION AND MAINTENANCE

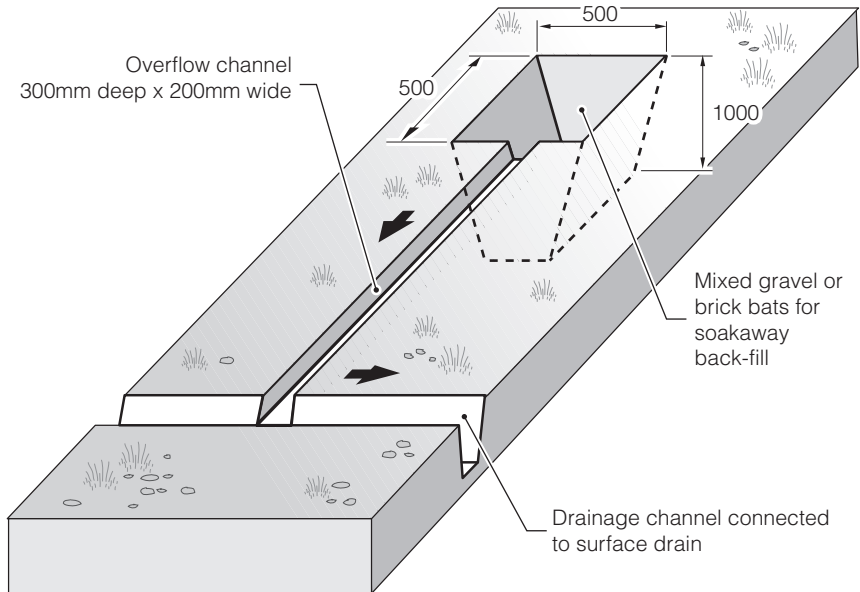
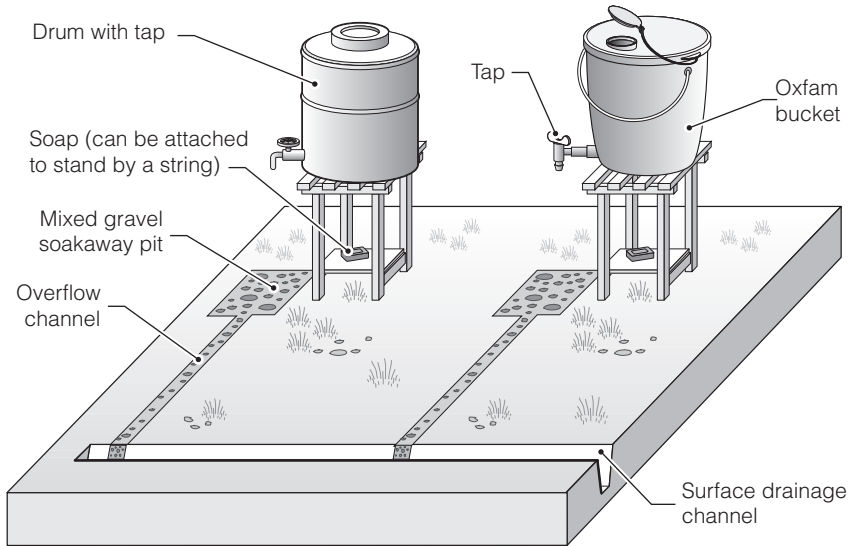

Soakaway detail

Figure 8.1. Traditional handwashing devices

EXCRETA DISPOSAL IN EMERGENCIES

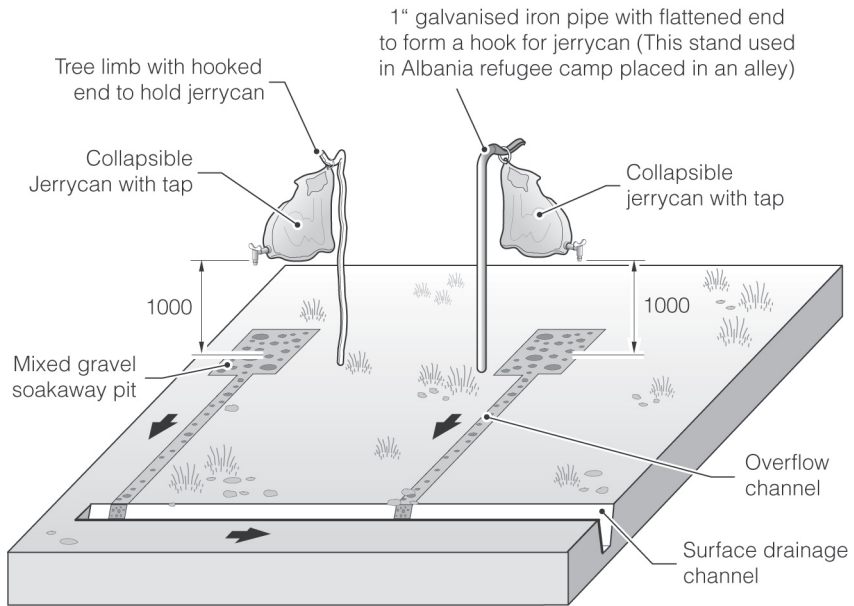

Jerrycan hanger

Figure 8.2. Traditional handwashing devices

8. OPERATION AND MAINTENANCE

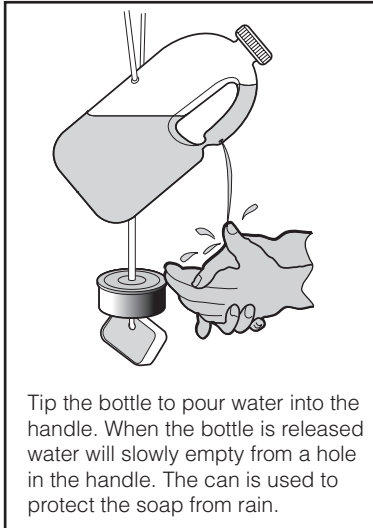

The Tippy Tap

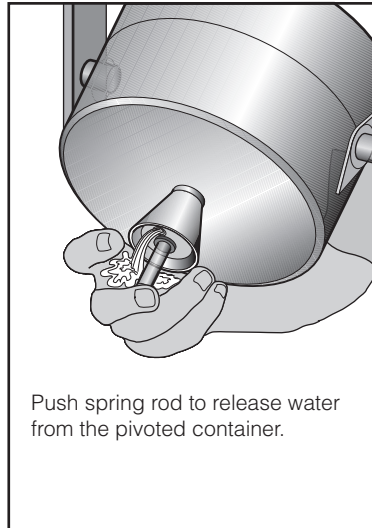

The Handy Andy

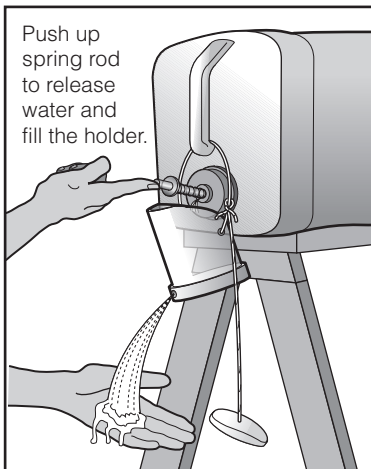

The Captap - Stage 1

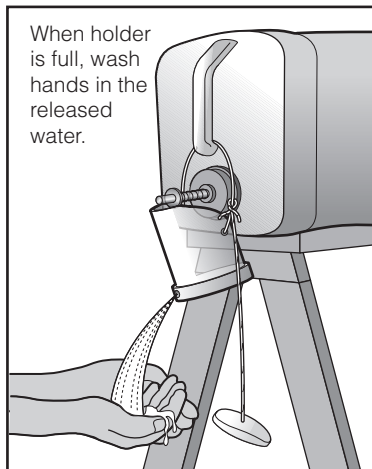

The Captap - Stage 2

Figure 8.3. Improved handwashing devices

In general, the handwashing options illustrated are for the 1st phase of an emergency or for family use. Heavy use may cause soakaway pits to clog up very fast with sand and soap and produce unpleasant odours. Because these devices contain only small volumes of water they must be regularly refilled, which poses a significant O&M issue.

Simple handwashing devices may be used in the initial emergency phase, but should be replaced by taps close to toilets as soon as possible.

8.4 Anal-cleansing material

Arrangements must be made to assure the availability of appropriate anal-cleansing materials at or near all latrines, and an appropriate method of disposal if necessary, as this is essential for hygiene. All people use some form of anal-cleansing material and it should not be assumed that the population will have their own supply. In the initial phase of an emergency it is essential that the affected community is consulted to determine the preferred and current methods of anal-cleansing. This is important to determine what facilities are appropriate and what measures need to be put in place (see Box 8.1). Where possible, the consultation process should occur in conjunction with public health promoters who should also promote handwashing after defecation and after handling infants' stools.

Anal-cleansing materials range from water to stones, leaves, corn husks and paper. However, while it is important to recognize what people traditionally use, there may also be the need to encourage people to use more available materials such as paper or water, in a densely populated site affected by an emergency.

Where water is used for anal-cleansing, a container of water should be supplied at or in facilities, together with small pots for individual use. This can be managed by the attendants along with the handwashing facilities. If this is not done, people may use plastic bottles and drop these into latrines making them inoperable.

Where solids are used, the appropriate material may also need to be provided. If biodegradable objects, such as corn cobs, are used it may be acceptable to drop these into latrines but these will cause pit latrines to fill up faster. Where space is limited or water-based sanitation systems are in

8. OPERATION AND MAINTENANCE

place it may be necessary to provide receptacles to collect soiled material. These materials should then be buried or burned and not deposited where they will create a health hazard.

Box 8.1.

Anal-cleansing in Afghanistan

In response to IDPs affected by severe drought conditions and the effects of civil war in Panjshir Valley, Afghanistan a hygiene-promotion programme commenced. Immediately there were reports of problems with anal-cleansing, particularly for children. Affected populations were apparently finding it difficult to use stones or mud because of the cold and, therefore, were not undertaking anal-cleansing properly. Also, some people were finding it difficult to excavate mud balls and store them in appropriate places, particularly bearing in mind the coming winter and snow cover in most of the valley.

As a result, some of the community members requested toilet paper, which the implementing agency decided not to provide as, not only did this go against cultural norms, it also provided only a temporary and unsustainable solution. The distribution of sufficient quantities of toilet paper for the whole of the winter to even 1000 families would have been an expensive and complicated matter. Also the problems as articulated by those people requesting toilet paper were not particularly convincing as local people in Panjshir had been managing well enough over countless previous winters. If the problem of storage for mud balls, peculiar to IDPs, was found to be the main issue, then it was agreed that the agency should look into ways of resolving this. Finally, it was decided to distribute plastic sheeting to facilitate outdoor storage.

8.5 Fly reduction

Flies, which tend to breed in areas where human excreta is present, can cause eye infections, particularly among infants and children – and can also be a vector in the transmission of diarrhoeal diseases. They are capable of transmitting dysentery and typhoid, although evidence suggests that they are rarely involved in the transmission of cholera. Flies may also influence whether people are willing to use facilities or not. Between five and ten thousand flies can breed in one kilogram or one litre of organic matter. They usually have a lifespan of one to two months. Fly-control measures include:

- physical screens;
- fly traps;
- lids on latrine squat-holes (except for VIP latrines);
- keeping latrine interiors dark;
- covering faeces with soil, ash or lime;
- regular cleaning of latrines;
- spraying of slab and superstructure with diesel; and
- applying chemical insecticides.

Reducing the number of flies quickly in an emergency can be difficult. Consulting with the affected community on the best method of controlling flies should be a first step in preventative action and, if necessary, educational measures should be promoted where the solutions chosen are unfamiliar. Physical screens or fly traps may be the best immediate measure. Installing vent pipes topped with anti-corrosive screens can reduce flies and smells, and lids should always be provided for squat-holes, except in the case of VIP toilets where a lid should not be used to allow air currents.

Preventative action to eliminate or limit breeding areas and make conditions less favourable to flies is the best long-term solution. Improving personal hygiene along with safe excreta disposal, drainage and garbage disposal will assist in prevention. Cleaning latrines regularly and storing food safely can help prevent the transfer of faecal-oral disease. It may also be relevant to look at the type of latrine model being used – for example, with trench latrines, using excavated soil to cover faeces after each use is recommended.

Chemical insecticides can also be used to kill flies. In general, however, systematic recourse to chemical control should be avoided, as such products are costly and toxic to humans and the environment, and insects can quickly develop resistance to the chemicals used. Insecticides should only be used when absolutely necessary and as a short-term measure. In some cases, small quantities of diesel have been used to spray the superstructure and latrine slab to deter flies. Typically, less than half a decilitre (0.05 litres) per latrine is needed.

Another way to reduce fly populations is to control fly larvae. The following options can be used to prevent fly-larvae growth:

- using a whitewash of lime and salt on pit walls to prevent the larvae from climbing the walls;
- regularly adding small amounts of ash, soil or lime to cover faeces;
- using biological larvicide and other organic products, including pyrethrum flower powder.

8.6 Sludge reduction

Sludge-reducing agents have been developed to speed up the sludge-digestion process. These bioadditives are designed to boost one or more of the three basic ingredients of digestion: nutrients, enzymes and bacteria. If successful, such bioadditives could be added to pit-latrines contents to reduce sludge volumes so that pits can be emptied less frequently.

Several studies testing the effectiveness of various sludge-reduction additives have indicated that some bioadditives are successful in accelerating reductions in sludge volumes and reducing fly infestation. In these trials, however, recorded increases in sludge-reduction rates vary considerably from 5% to 50% – and all studies indicate the need for further testing and research (Redhouse, 2001).

Due to the generally faster rate of sludge accumulation in emergencies, it is not yet known how appropriate such technologies are for emergency excreta disposal programmes. There are also significant constraints to their application, including cost, procurement and, ideally, the need for regular stirring to maximize volume reduction.

Sludge-reduction bioadditives do not increase liquefaction of sludge and, therefore, do not make it any easier to empty latrines by desludging.

8.7 Latrine desludging

Many excreta disposal technology choices involve the construction of a pit or tank which does not rely on infiltration but will need emptying if used in the long-term. Where possible, pits should be appropriately sized or replaced to prevent the need for regular emptying or desludging. This is not always possible, often due to lack of space, and where this is the case facilities for emptying must be in place. Desludging should be considered in situations where:

- land availability is scarce, i.e. it is not possible to dig another pit nearby when one is full;
- ground conditions mean that raised latrines have had to be built: e.g. high water-table, impermeable ground or hard rock areas; or
- latrine pits have been lined, for stability or to prevent groundwater pollution (if the pit is not lined there is a danger of pit collapse when the solids are removed).

If latrines are to be desludged, then either the hole in the squatting-slab needs to be large enough to allow a hose through for pumping; or a removable slab or a removable cover, outside the cubicle, needs to be made to allow a hose or a person to enter. The preferable option is a removable cover so that solids that cannot be pumped out can be dug out and any spillage during desludging does not contaminate the inside of the latrine.

When the contents of the pit or tank are to be pumped out and the sludge is too firm or dry it may be necessary to jet on water and agitate the mixture of sludge and water with the end of the suction hose before pumping begins.

Mechanical emptying

The easiest and most hygienic method for emptying latrines is to use a vacuum tanker (sometimes known as a 'sludge-gulper') which is a truck with a large tank fitted with a mechanical pump. After pumping out the contents of the pit, the tanker can be driven to a safe-disposal site, such as an off-site underground pit or sewage treatment works, where the contents can be emptied. Vacuum tankers are good at removing liquids but poor at removing solid material. Dry pits or pits containing large quantities of solid materials such as stones, sticks, plastic bags, etc. cannot be

8. OPERATION AND MAINTENANCE

emptied. Another problem with vacuum tankers is that they are very large and may be difficult to manoeuvre close to latrines.

Where a purpose-built vacuum tanker is unavailable or inappropriate, a collection tank can be mounted on a flat-bed truck, and a portable pump used to pump the waste from the pit to the tank. Such pumps must be carefully selected, particularly where hard anal-cleansing materials are used, and specialist sewage pumps are recommended. Centrifugal desludging pumps are most suitable for wet conditions and, if necessary, a small volume of water can be pumped into the pit first and stirred into the sludge to help liquefy it. Diaphragm desludging pumps which can operate at lower flow rates are also available, and may be more effective in emptying pit latrines than high flow-rate centrifugal pumps.

Electrical submersible sludge pumps can also be used for desludging pit latrines. Such a pump has a metal grill to prevent large bits of rubbish, bottles, bones etc., clogging up and jamming the impeller. If extra pumping head is required these pumps can be put in series. Pumps can be used to pump slurry into ex-water tankers, barrels or metal tanks mounted on flat bed trucks, or tanks for transportation to a disposal area. The aim of this type of desludging is not to remove everything from the latrine – only the slurry component. Removing the top two-thirds of the pit sludge can extend the life of the latrine by a few years before, eventually, the compacted solids will have to be dug out by hand.

Hand-operated latrine-emptying pumps are available in some countries, such as MAPET in Tanzania and Vacutug in Kenya, Bangladesh and Mozambique (for more information see UN-HABITAT, 2006). These are usually mounted on a hand-pushed cart which can be wheeled close to the pit to be emptied. These are much slower than a mechanical pump and some experience is necessary. Such pumps are most appropriate if available and used locally, and where pit contents are wet.

Box 8.2 describes different options used for desludging in Mozambique.

Difficulties encountered in mechanical desludging include:

- difficult vehicular access to latrines;
- dry excreta with little liquid content which cannot be pumped, and lack of available water to dilute pit contents;
- solid anal-cleansing materials which clog up pump or hose;

- difficulty keeping up with demand where there are large numbers of pits that fill rapidly;
- lack of an appropriate site for final disposal of waste; and
- where latrines are inaccessible or poorly maintained, people may choose instead to defecate into plastic bags and throw them into the latrines – this is likely to block up the sludge truck.

In general, it is easier to empty septic-tanks than latrine pits because the septic-tank sludge is much less dense. Consequently, a medium-powered vacuum pump is usually strong enough to lift septic-tank sludge.

Manual emptying

As a last resort, pits can be emptied manually. This generally involves workers climbing into the pit and using shovels and buckets to take the waste out. This can then be placed in a wheelbarrow, or truck, and taken to a safe off-site disposal site. This should only be attempted once a pit has been closed and the contents left to decompose for some time (preferably at least one year and ideally two years). This allows sufficient time for *Ascaris* (roundworm) eggs, which are the most persistent pathogen, to die off. This period can be shortened by raising the pH (by adding lime or other alkaline material), raising the temperature, or reducing the moisture content.

Although many cultures have a tradition of hand-emptying pits, in densely populated areas this should be avoided if at all possible. It is also important to check with local authorities, as the practice is illegal in some countries.

In Katale Camp, Goma in 1995, latrines were emptied using buckets which were subsequently emptied into 200-litre drums on 3-tonne trucks, which disposed of the material in a dump some 6km away. Approximately 100m³ sludge for 150,000 people was evacuated every week using this method.

Box 8.2.

Desludging after a flood in Mozambique

In response to the floods in Mozambique in 2000, a large desludging programme was initiated to desludge overflowed septic-tanks during the 2nd phase. This took place in a town with a large IDP population, which had a pre-existing sewerage system servicing houses with septic-tanks. During the floods, the septic-tanks became full with mud and floodwater and had to be emptied quickly.

In this case, there was no desludging truck available, so an electric, submersible sludge pump was ordered. More water was added to the septic-tanks, and a hole was dug away from the tanks, a fair distance from the houses. The team then pumped water from the septic-



tank into the hole and afterwards covered it back up with soil, and then dug out the residue at the bottom of the tanks by hand. This option was chosen because access to a truck was unfeasible, and roads were very difficult to access. The pump proved to be particularly useful in this context and didn't jam despite handling large amounts of waste – however this was directly dependent on water being mixed with the waste to increase the liquid content. Previously, the pump had not been tested for desludging.

One of the cheapest methods of desludging is to use a trailer-mounted agricultural muck-spreader which has an in-built vacuum pump, as seen in the photograph (right) in Chokwe, Mozambique.



Box 8.2. continued..

In other programmes in Mozambique the Vacutug (pictured) was used, with the advantage of greater manoeuvrability and easier access to latrines.

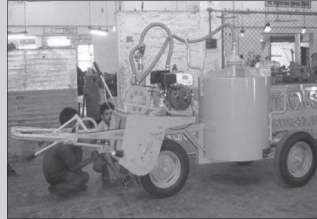

Sludge disposal

Sludge that has been left undisturbed for over two years is not a hazard to the environment. It can safely be spread anywhere convenient such as a garden or refuse tip. Its fertilizer value is not good but it will add humus and fibre to the soil which will promote plant growth.

Open disposal of fresh sludge into water or onto land is undesirable – it is an environmental and health hazard. The best solution is to bury sludge in pits where it cannot come into contact with humans or animals, and will not contaminate groundwater sources. Alternatives are to mix it with the influent at a nearby sewage works or compost it with domestic refuse.

Untreated fresh sludge can be used as a fertilizer but great care should be taken to avoid contamination of crops. It is preferable to leave the sludge undisturbed for a long period or to compost it.

For composting, the sludge should be mixed with two or three times its volume of vegetable waste. It is then piled into windrows (long heaps, typically about 2m wide at the top, 2m high, with sides sloping at about 45°) for several weeks. It can then be used as fertilizer.

Sludge can also be disposed of in drying beds. These are usually shallow trenches (about 300mm deep) and should only be used where the groundwater is more than 1.5m below the base of the pit. In permeable conditions this allows the liquids to infiltrate and the sludge can be left to dry so that it can be removed manually. The period it should be left will depend on the temperature, humidity and rainfall, but this should be **at least** two weeks.

8.8 Decommissioning facilities

In some scenarios involving temporary facilities it may be necessary to develop a programme for dismantling and decommissioning excreta disposal facilities. The organization responsible for latrine construction is normally also responsible for decommissioning.

Some key issues to consider in decommissioning are outlined below:

1. Decommissioning should ideally be carried out during the 'dry' season when the pit or tank contents will have had the most opportunity to dry out.
2. Staff should be trained and provided with protective clothing in order to dismantle superstructures, remove latrine slabs and pipes, and backfill pits.
3. Lime or another form of disinfectant should be used to clean latrine slabs or pedestals, and to mitigate against unpleasant odours. It can also be added to latrine contents to aid decomposition, though this is not normally necessary when pits are to be filled and sealed with earth.
4. If the pit contents are wet it may be necessary to dig an overflow trench from the top of the pit or tank to absorb displaced fluids. This should be made large enough to allow a large quantity of material to be placed into the pit or tank. The trench can either be dug around the top of the latrine or out as a single line drain to work as a leach field.
5. Cement debris from the latrine structure or other dismantled facilities can be thrown into the pit along with wood chips, ash or other available organic matter to aid decomposition. As these are added, fluids will overspill into the overflow trench; once the flow stops this can then be backfilled with soil and site rubble.
6. The pit or tank should then be capped with a mound of soil and rubble to allow for further settling of contents.
7. Vegetation can be planted on the latrine site if in line with site rehabilitation. If not, a larger pile of debris should be placed over the filled pit to allow for further subsidence as the contents settle and decompose further. Capping with concrete should be considered if in a populated area where interference is possible.

EXCRETA DISPOSAL IN EMERGENCIES

8. If possible the area should be fenced off to prevent it from being disturbed.
9. Used, prefabricated plastic superstructure units may become a solid waste problem. If these cannot be re-used they should be recycled or disposed of in conjunction with local authorities.